

BONE HOLDING

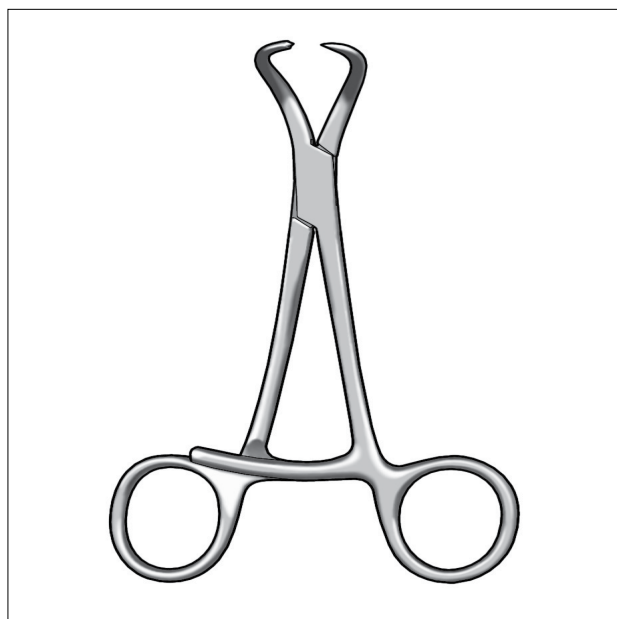

SECTION L



To hold, stabilize, rotate, reduce and compress bone.

CONTENTS

Bone Holding Forceps	1-17
Bone Reduction Forceps	3-7
Pelvic Reduction Forceps	8-10
Bone Holding Clamps	11-13
Self-Retaining Forceps	18
Reduction Clamps	19-20
Repofix Forceps	21-22

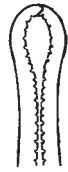
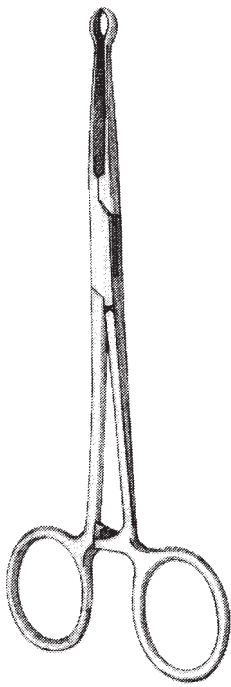

Very useful for removing the sesamoid bone.

OM 69-0787
6" (152mm)
1x2 teeth
serrated jaws

LOCKE PHALANGEAL FORCEPS

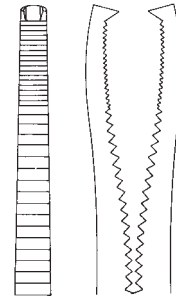
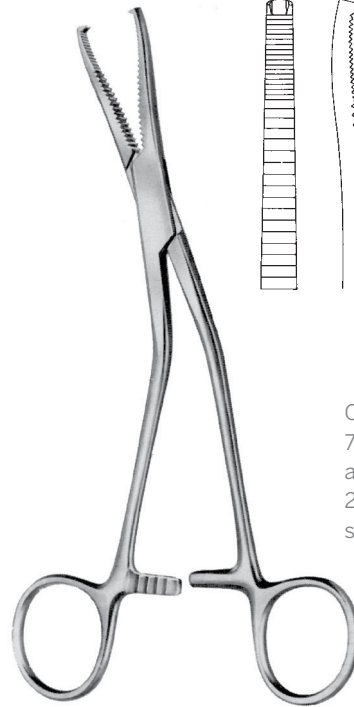

Delicate serrated jaws for holding small bone fragments.

OM 46-0804
7 1/2" (191mm)
angular
2x2 sharp teeth
serrated jaws

DINGMAN CARTILAGE AND BONE CLAMP



OM 69-0795
6 1/2" (165mm)
slightly curved

SESAMOIDECTOMY CLAMP



OM 47-0139
4 3/4" (121mm)
one pointed tip
and foot plate

PLATE AND BONE HOLDING FORCEPS



For positioning mini bone plates.



Allows for placement of the bone clamp where it can best stabilize the bone fragments. The drill guide allows for screw placement through the opening at the top of the clamp.

- curved
- OM 90-1890-01
Small with 8mm drill guide with ratchet
- OM 90-1890-02
Large with 10mm drill guide with ratchet
- OM 90-1890-XSM
Extra small with 6mm drill guide with ratchet

O'BRIEN BONE CLAMP

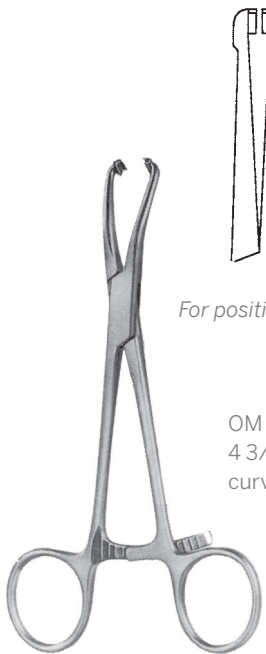

For positioning small bone plates.

- OM 47-0138
- 4 3/4" (121mm)
- curved

PLATE AND BONE HOLDING FORCEPS



- OM 47-0130
- 7" (178mm) serrated
- slightly curved

- OM 47-0131
- 7" (178mm) serrated
- with long ratchet
- slightly curved

LEWIN BONE FORCEPS



OM 47-0012
7" (178mm)
with speed lock
2x2 sharp teeth

PATELLA FORCEPS

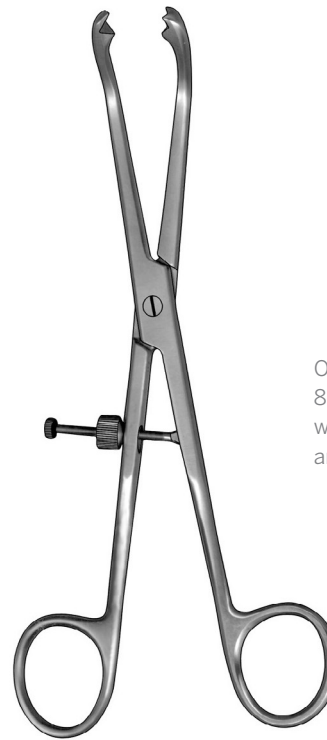

OM 47-0170
8 1/2" (216mm)
with speed lock
angular tip

FIBULA FORCEPS



*Grasping forceps
for small bones.*

OM 47-0010
8 1/4" (210mm)
1x1 sharp points

MALLEOLLAR FORCEPS

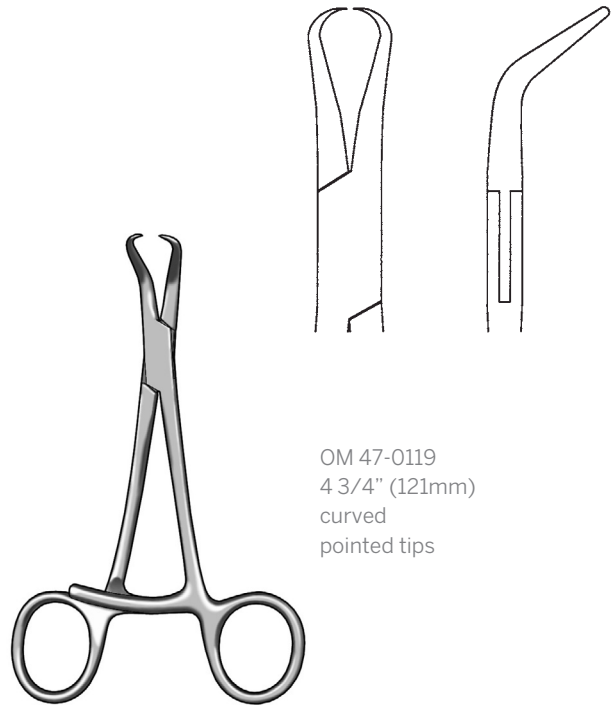

OM 47-0119
4 3/4" (121mm)
curved
pointed tips

**STAGBEETLE BONE
REDUCTION FORCEPS**

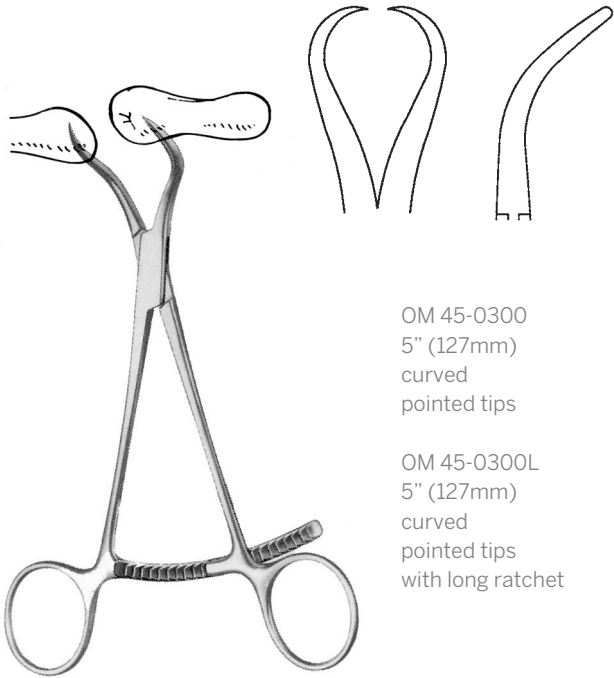

OM 45-0300
5" (127mm)
curved
pointed tips

OM 45-0300L
5" (127mm)
curved
pointed tips
with long ratchet

BONE REDUCTION FORCEPS

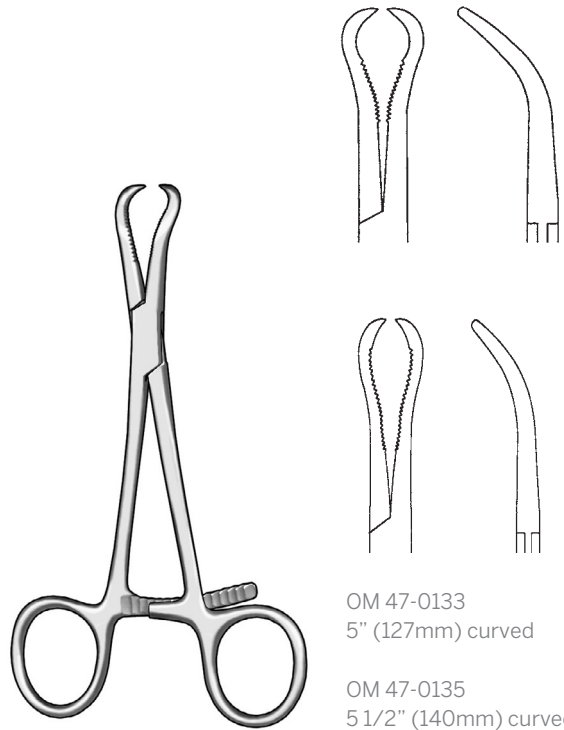

OM 47-0133
5" (127mm) curved

OM 47-0135
5 1/2" (140mm) curved

BONE REDUCTION FORCEPS

Serrated with pointed tips

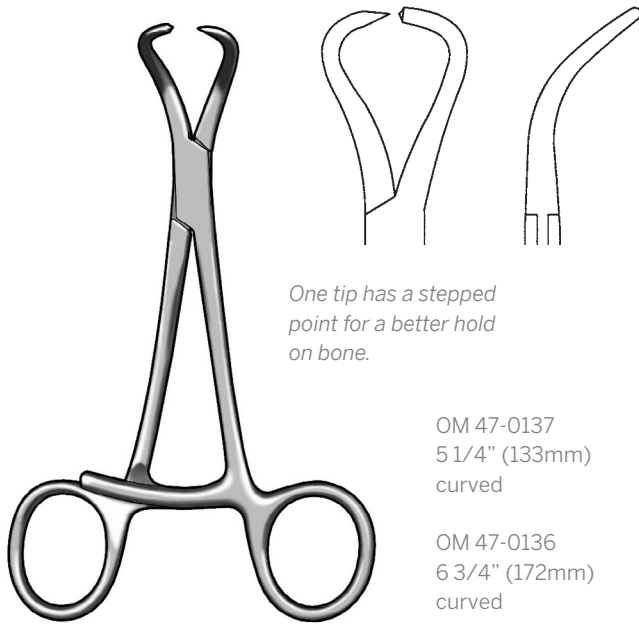

One tip has a stepped point for a better hold on bone.

OM 47-0137
5 1/4" (133mm)
curved

OM 47-0136
6 3/4" (172mm)
curved

BONE REDUCTION FORCEPS

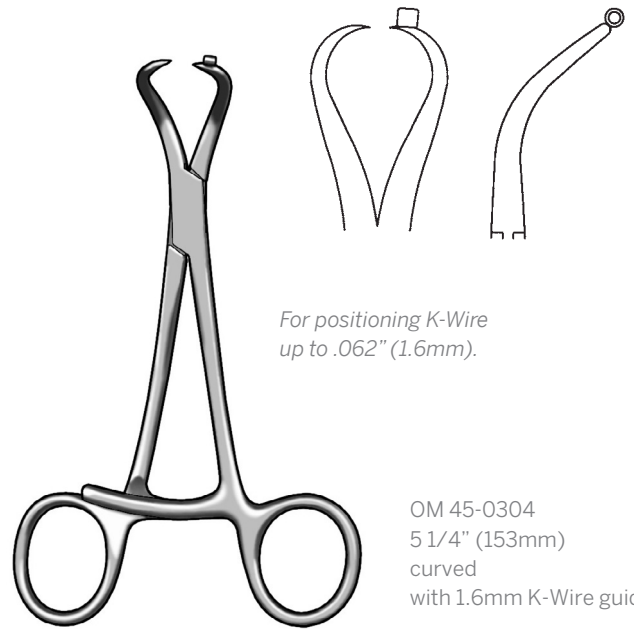

For positioning K-Wire up to .062" (1.6mm).

OM 45-0304
5 1/4" (153mm)
curved
with 1.6mm K-Wire guide

BONE HOLDING FORCEPS

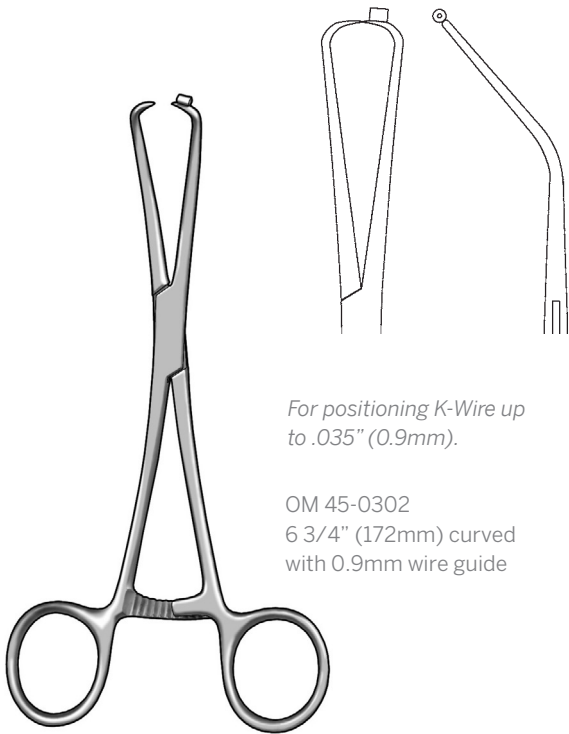

For positioning K-Wire up to .035" (0.9mm).

OM 45-0302
6 3/4" (172mm) curved
with 0.9mm wire guide

BONE HOLDING FORCEPS

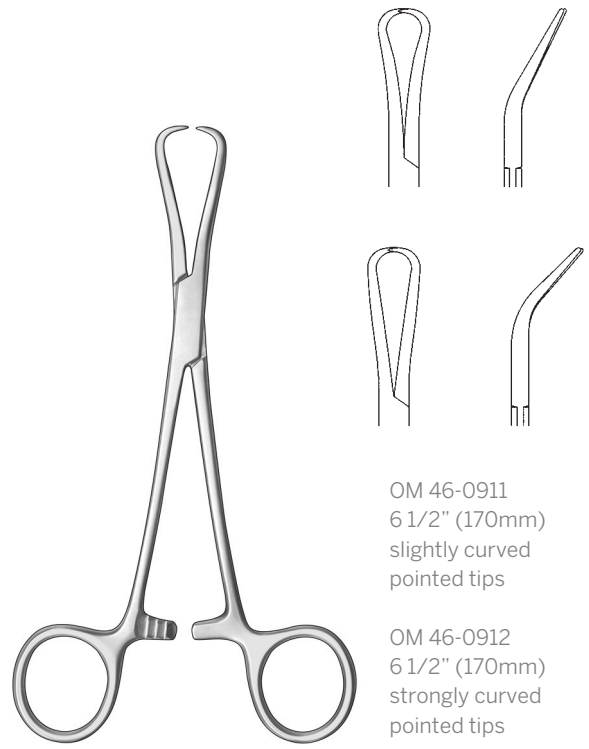

OM 46-0911
6 1/2" (170mm)
slightly curved
pointed tips

OM 46-0912
6 1/2" (170mm)
strongly curved
pointed tips

GLENOID PERFORATING FORCEPS

OM 47-0129
6" (152mm)
angular
inside fenestration: 22mm x 14mm
outside fenestration: 30mm x 20mm
ratchet length: 3"

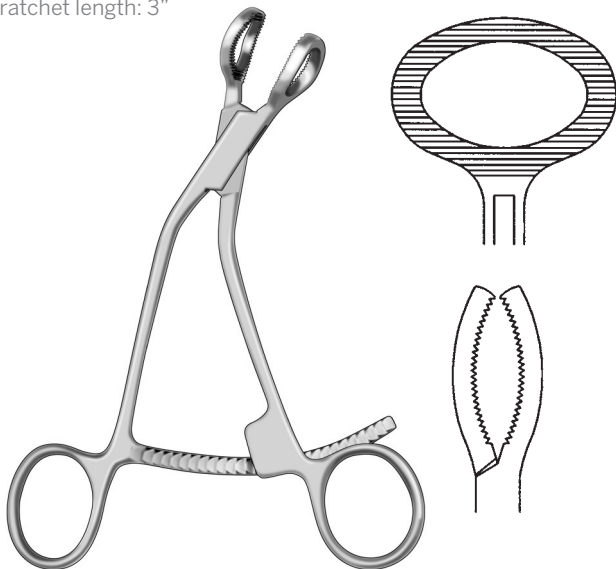

BONE HOLDING FORCEPS
with fenestration

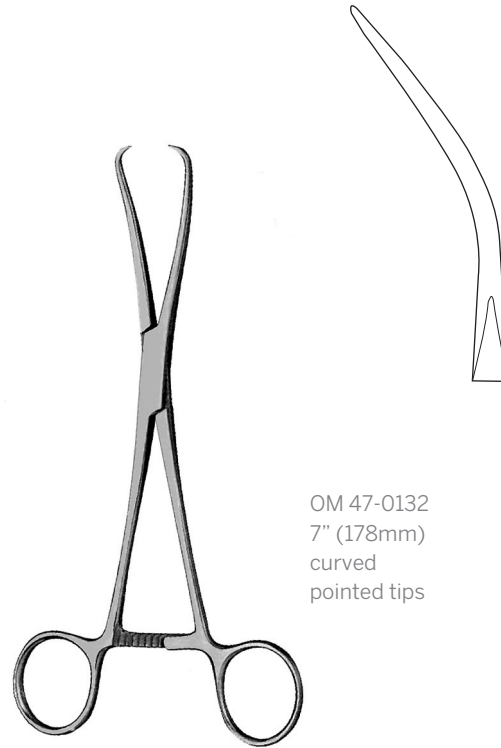

OM 47-0132
7" (178mm)
curved
pointed tips

REILL BONE REDUCTION FORCEPS



BONE REDUCTION FORCEPS

OM 47-0127 5 1/2" (140mm) curved narrow tip

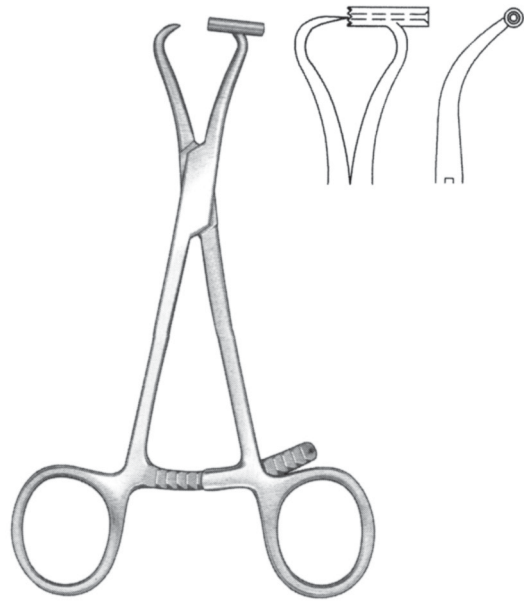

OM 45-0305 5" (127mm) .035" (0.9mm) curved
 OM 45-0306 5" (127mm) .045" (1.1mm) curved
 OM 45-0307 5" (127mm) .062" (1.6mm) curved

BONE HOLDING FORCEPS

With K-Wire guide

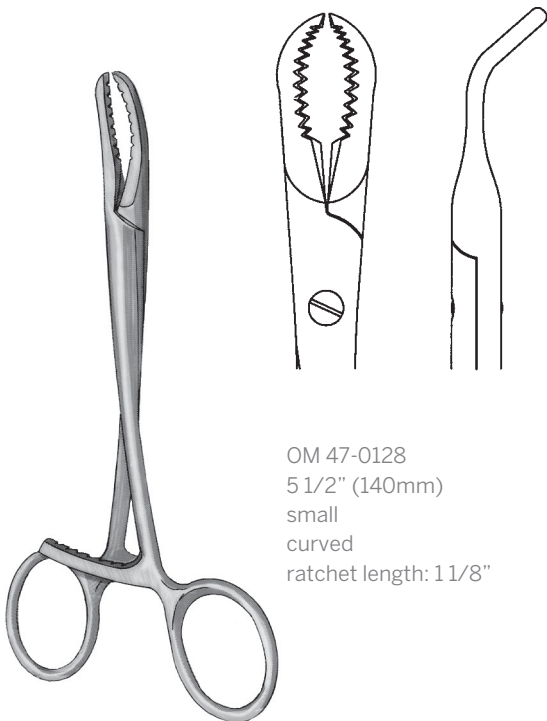

OM 47-0128
 5 1/2" (140mm)
 small
 curved
 ratchet length: 1 1/8"

BONE REDUCTION FORCEPS

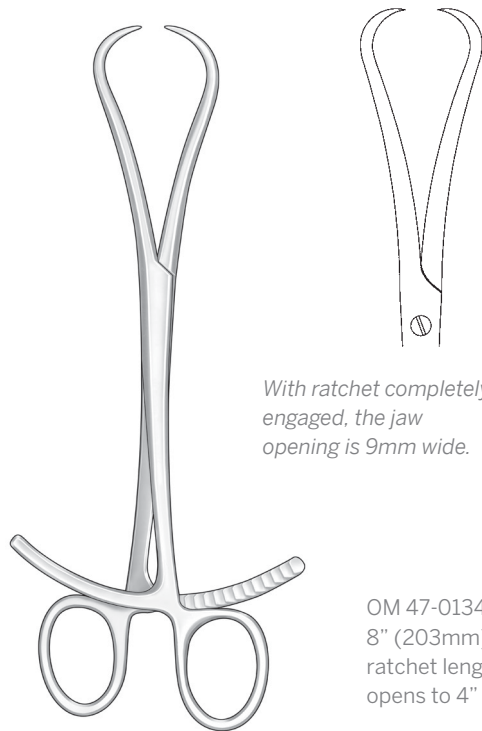

With ratchet completely engaged, the jaw opening is 9mm wide.

OM 47-0134
 8" (203mm)
 ratchet length: 2"
 opens to 4"

BONE REDUCTION FORCEPS



OM 45-0326
10 1/4" (260mm)

REPOSITION FORCEPS



OM 90-1830
Small, 5 1/2" (140mm) with speed lock

OM 90-1835
Medium, 6" (152mm) with speed lock

OM 90-1840
Large, 8" (203mm) with speed lock

BONE FRAGMENT CLAMP



OM 47-0135L
5 1/2" (140mm) curved
serrated with pointed tips extra
long ratchet

BONE REDUCTION FORCEPS

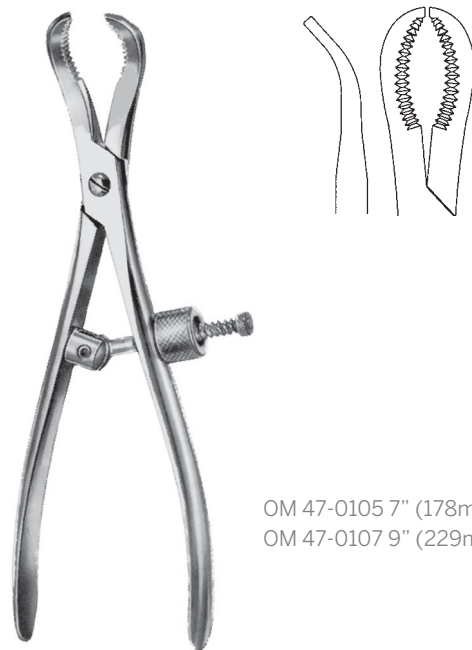

OM 47-0105 7" (178mm) curved
OM 47-0107 9" (229mm) curved

BONE REDUCTION FORCEPS

With speed lock



OM 47-0074
7 1/2" (191mm)
curved sideways
deep teeth
without ratchet



OM 47-0076
8" (203mm)
curved sideways
deep teeth
with ratchet

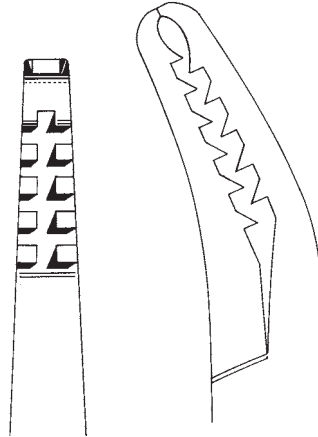

SEMB BONE HOLDING FORCEPS

With or without ratchet



OM 47-0072
9" (229mm)
curved sideways
serrated



VAN BUREN SEQUESTRUM FORCEPS



OM 47-0198
8 1/4" (210mm)
deep teeth

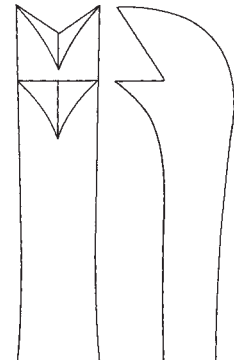

FERGUSSON BONE HOLDING FORCEPS



OM 47-0200
8 1/4" (210mm)
2x2 teeth

LANGENBECK BONE HOLDING FORCEPS

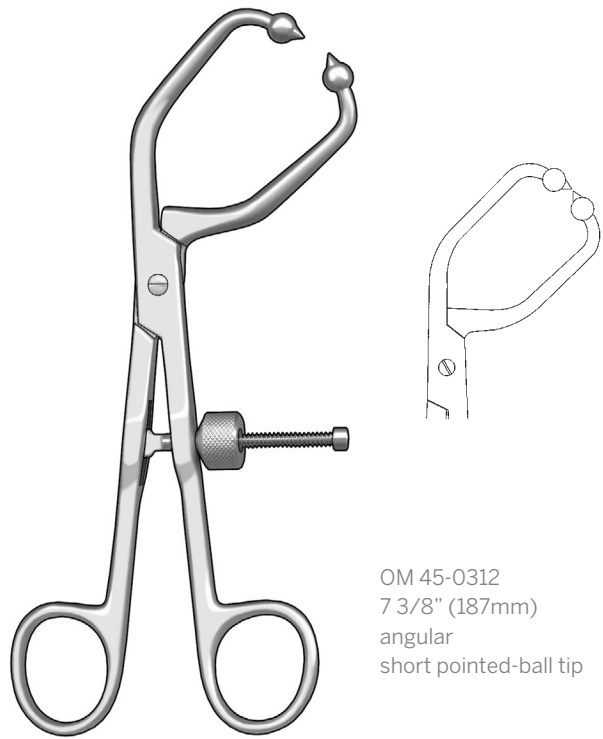

OM 45-0312
7 3/8" (187mm)
angular
short pointed-ball tip

PELVIC REDUCTION FORCEPS

Short tips

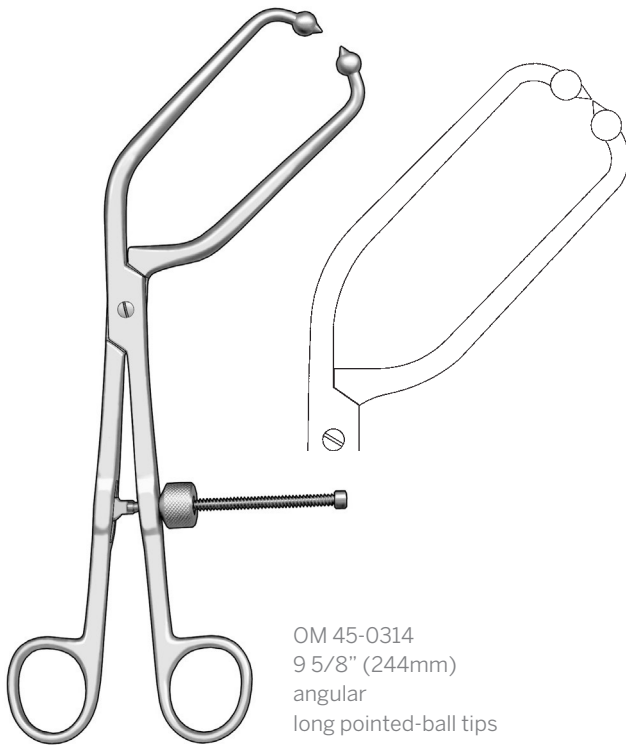

OM 45-0314
9 5/8" (244mm)
angular
long pointed-ball tips

PELVIC REDUCTION FORCEPS

Long tips

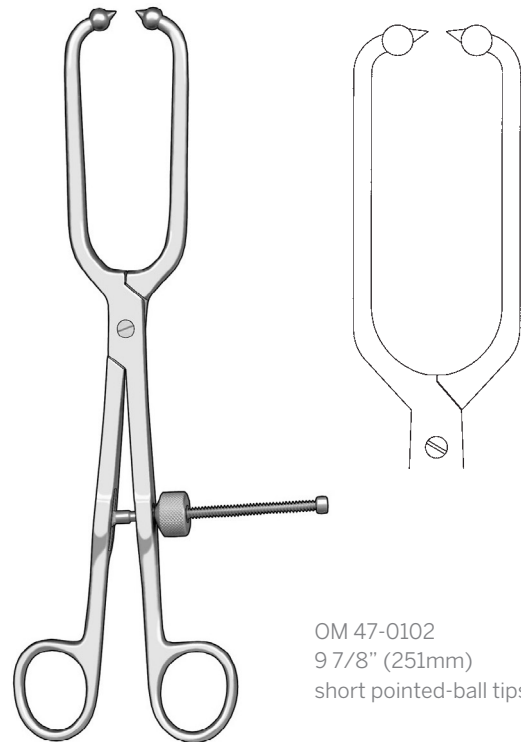

OM 47-0102
9 7/8" (251mm)
short pointed-ball tips

PELVIC REDUCTION FORCEPS

Angled tips

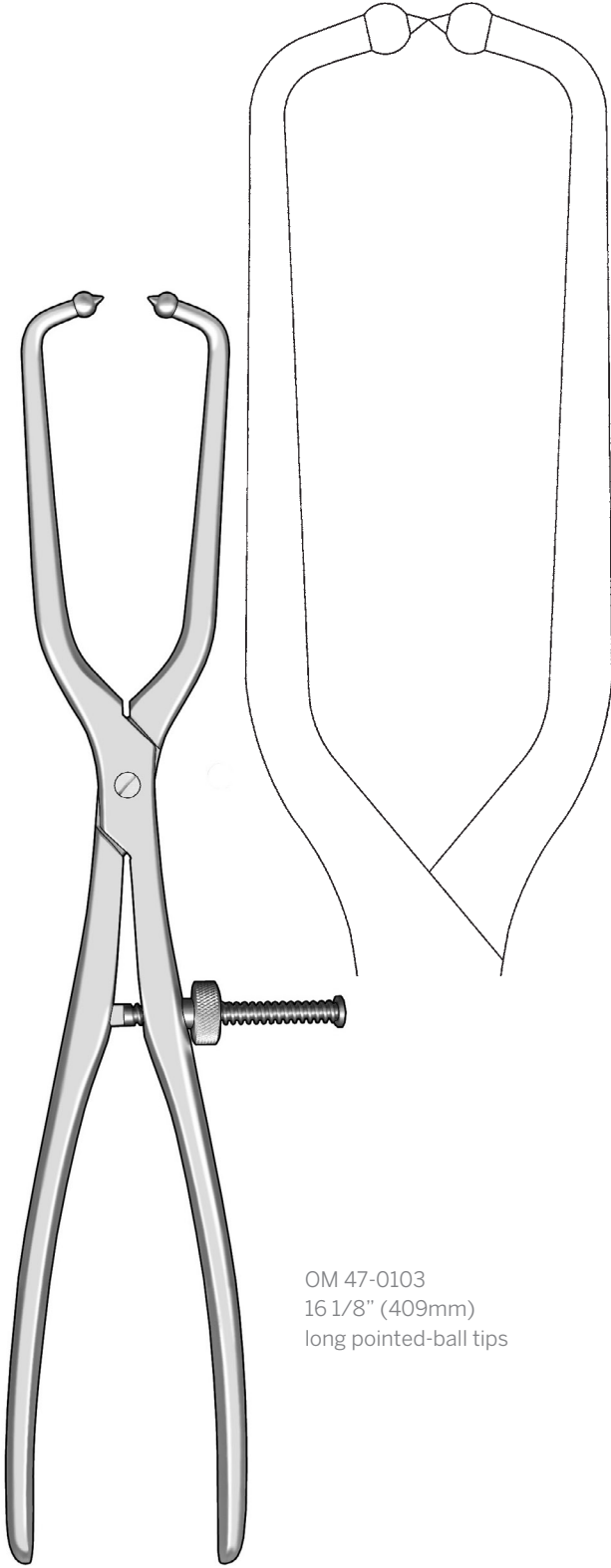

OM 47-0103
16 1/8" (409mm)
long pointed-ball tips

PELVIC REDUCTION FORCEPS

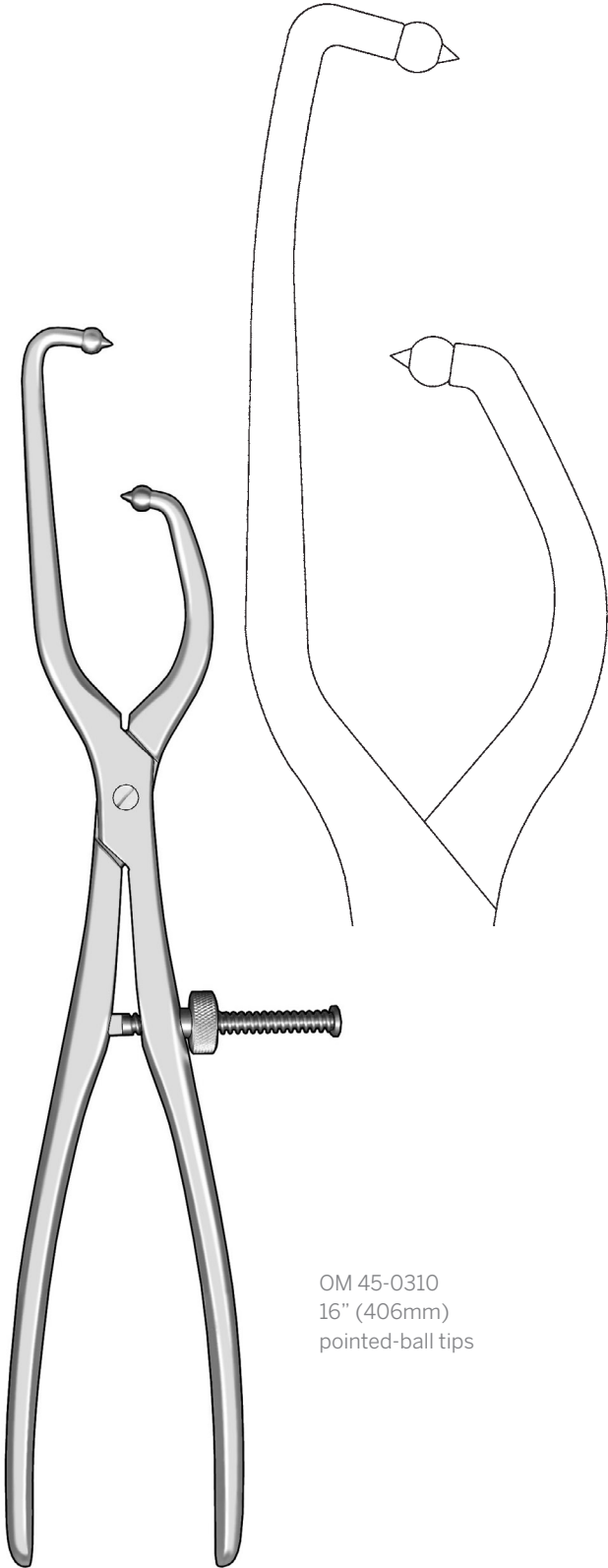

OM 45-0310
16" (406mm)
pointed-ball tips

ASYMMETRIC PELVIC REDUCTION FORCEPS

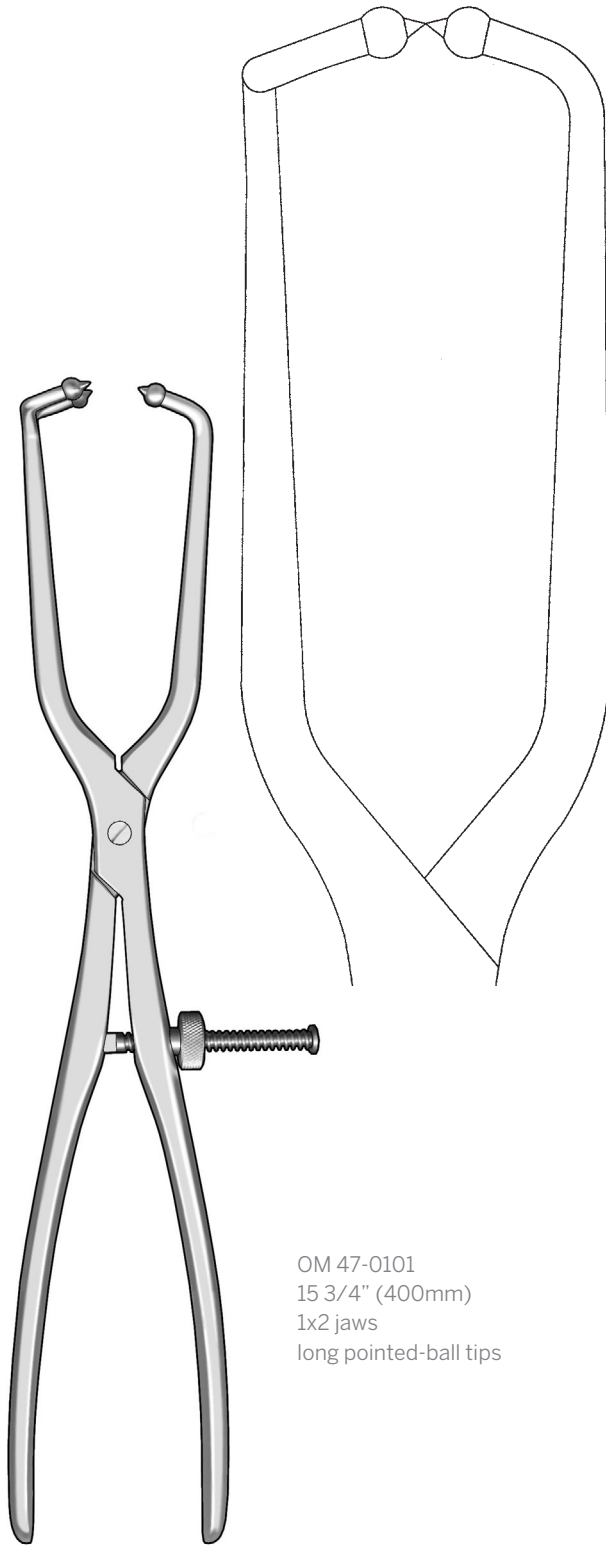

OM 47-0101
15 3/4" (400mm)
1x2 jaws
long pointed-ball tips

PELVIC REDUCTION FORCEPS

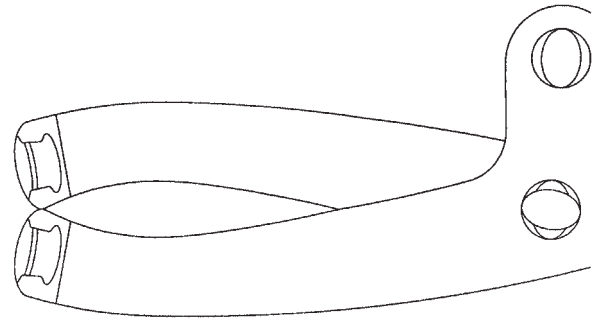

OM 47-0100
13 1/2" (343mm)
with screws

PELVIC REDUCTION FORCEPS

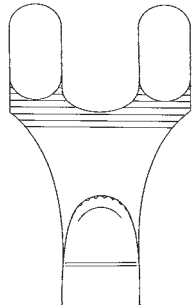
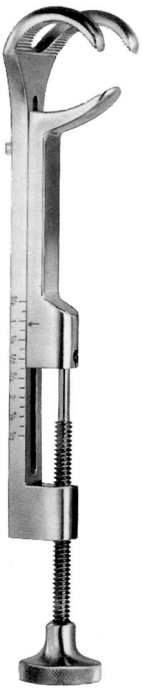

OM 47-0140
4 3/4" (121mm)

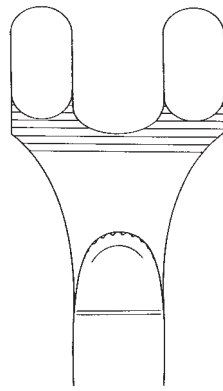

OM 47-0154
7 1/4" (184mm)

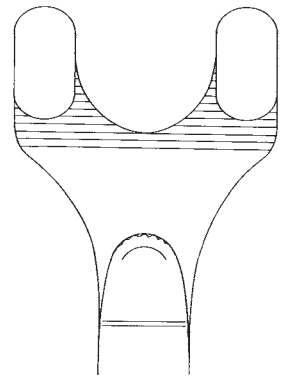

OM 47-0156
8" (203mm)

*Calibrated in inches to
measure bone diameter.*

LOWMAN BONE CLAMP

1x2 jaws

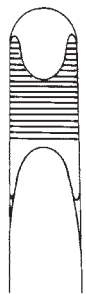
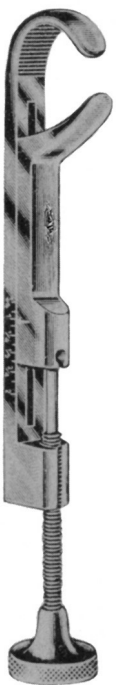

OM 47-0160
4 3/4" (121mm)

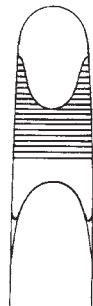

OM 47-0164
7 1/4" (184mm)

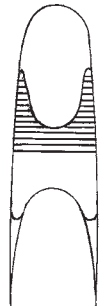

OM 47-0166
8" (203mm)

*Calibrated in inches to
measure bone diameter.*

LOWMAN BONE CLAMP

1x1 jaws

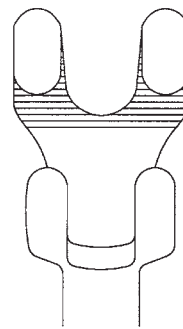
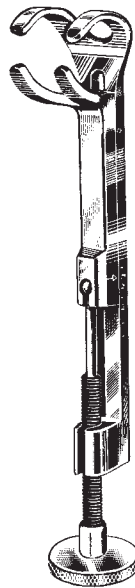

OM 47-0167
7 1/4" (184mm)

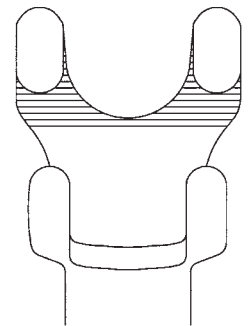

OM 47-0168
8" (203mm)

*Calibrated in inches to
measure bone diameter.*

LAMBERT-LOWMAN BONE CLAMP

2x2 jaws



OM 47-0054
5 3/4" (146mm)
mini

OM 47-0056
8 1/2" (216mm)

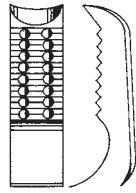

KERN BONE FORCEPS
Without ratchet



OM 47-0062
5 3/4" (146mm)
mini

OM 47-0064
8 1/2" (216mm)

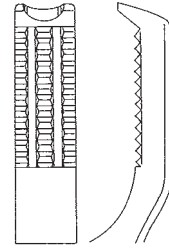

KERN BONE FORCEPS
With ratchet



OM 47-0078
13" (330mm)
light model
without ratchet

OM 47-0080
13" (330mm)
light model
with ratchet

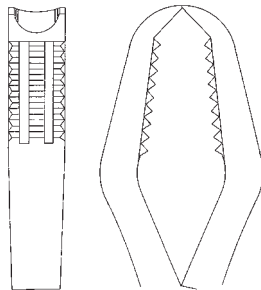

LANE BONE HOLDING FORCEPS
Without ratchet



*Particularly well suited
for use during insertion of
intermedullary nails.*

OM 47-0068
13" (330mm)
standard model
without ratchet

OM 47-0082
13" (330mm)
standard model
with ratchet

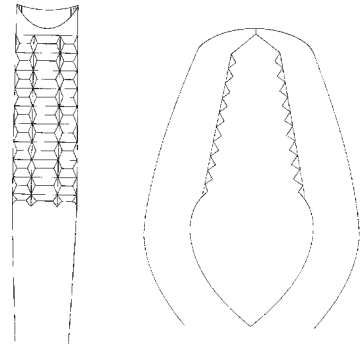

LANE BONE HOLDING FORCEPS
With ratchet

OM 47-0070
17" (432mm)
without ratchet



LANE BONE FORCEPS
Without ratchet

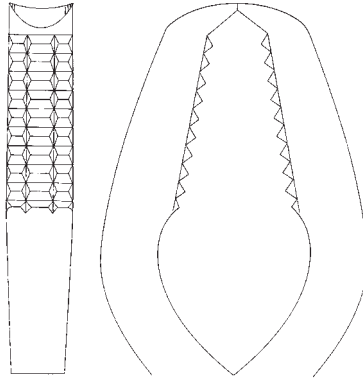

OM 47-0084
17" (432mm)
with ratchet

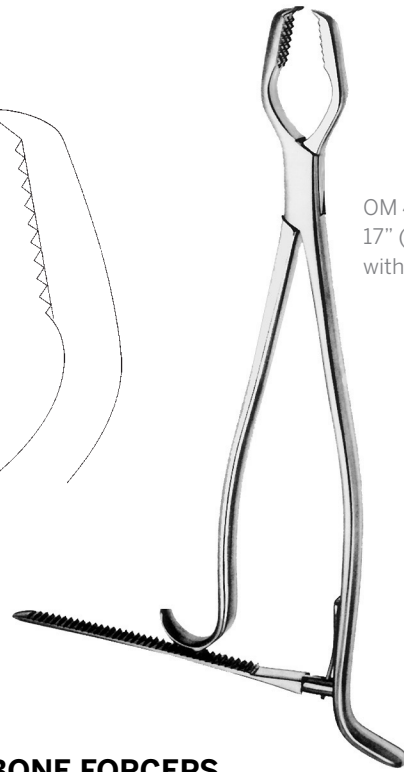

LANE BONE FORCEPS
With ratchet

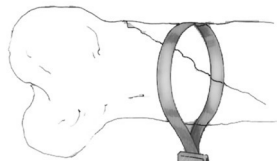

*Fit thin end of band through slot
in other end of band. Insert thin
end into clamp.*

OM 47-0172
8 1/2" (216mm)
bands not included

OM 47-0173
single band only

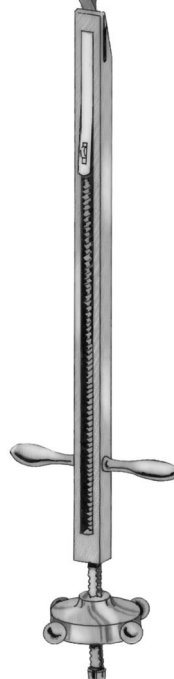

PARHAM-MARTIN BONE CLAMP

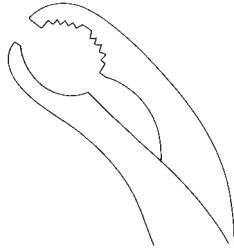

OM 47-0090
6" (152mm)

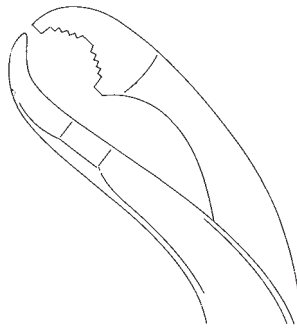

OM 47-0092
7 1/2" (191mm)

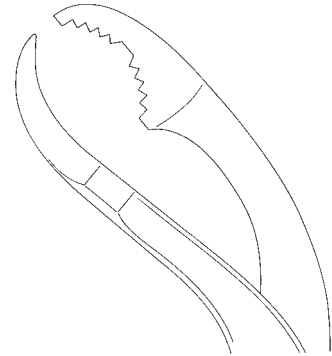

OM 47-0094
9 1/2" (241mm)

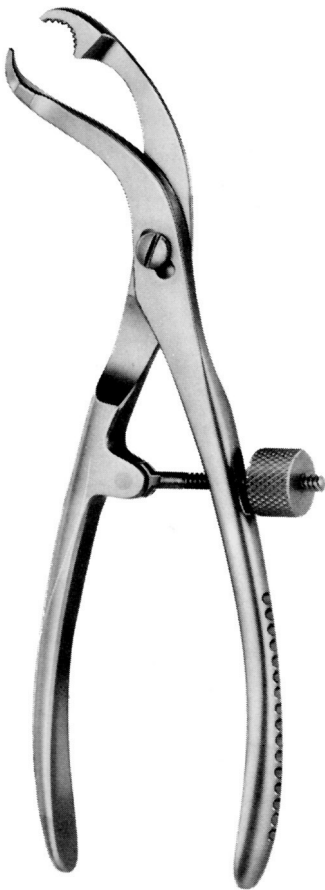

OM 47-0096
10 1/4" (260mm)

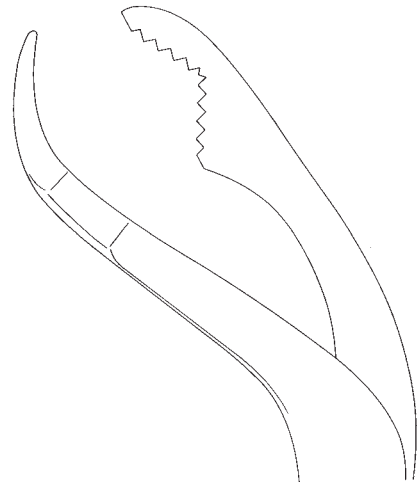
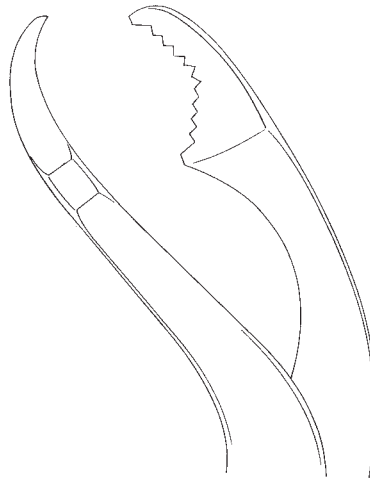

OM 47-0098
11" (280mm)

VERBRUGGE BONE HOLDING FORCEPS

Self centering, with speed lock

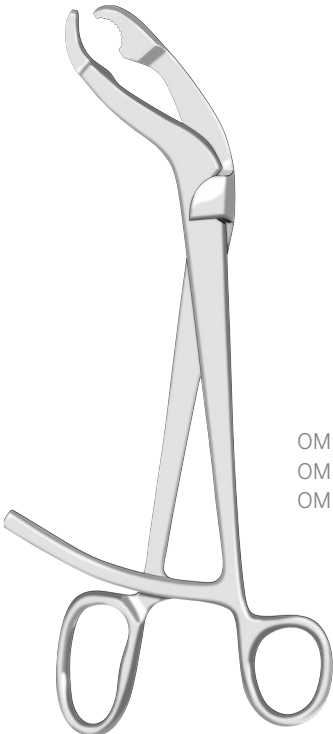

OM 47-0122 10" (254mm)
OM 47-0124 10 1/2" (267mm)
OM 47-0126 11" (280mm)

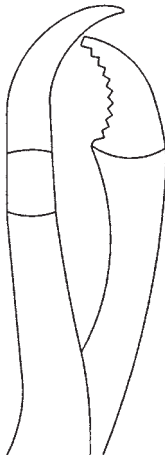
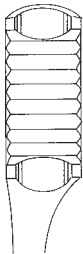

OM 47-0122

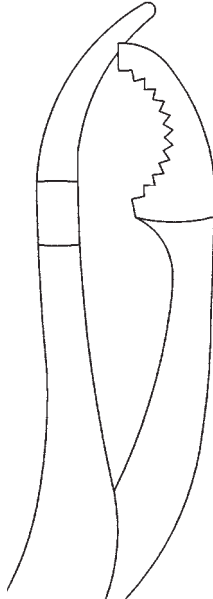

OM 47-0126

VERBRUGGE BONE HOLDING FORCEPS

With long ratchet

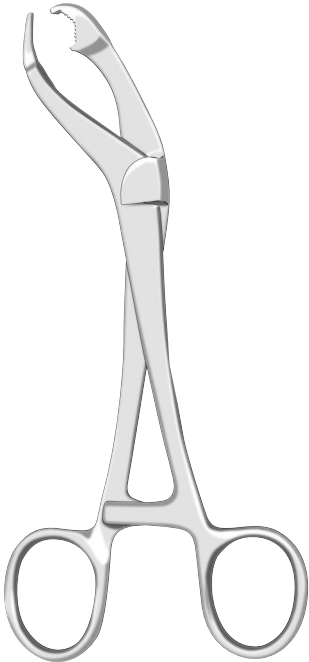

OM 47-0120
6 3/4" (172mm)

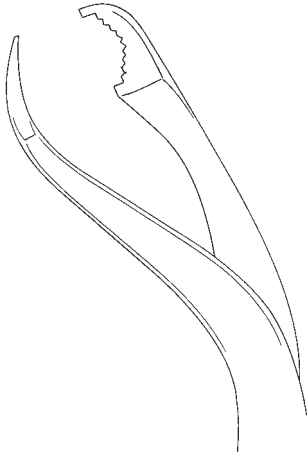
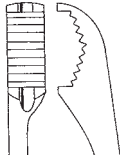

VERBRUGGE BONE HOLDING FORCEPS

With short ratchet

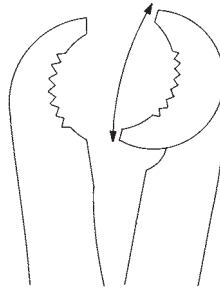

OM 47-0204

- OM 47-0204 8 1/2" (216mm)
- OM 47-0206 10 1/2" (267mm)
- OM 47-0208 11 1/2" (292mm)



LAMBOTTE BONE HOLDING FORCEPS

With swivel head, adjustable jaw

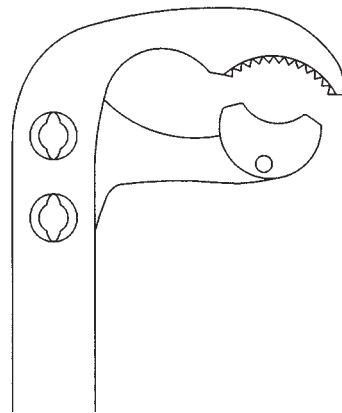

- OM 47-0212
- 8 1/2" (216mm)
- with swivel head, adjustable jaw

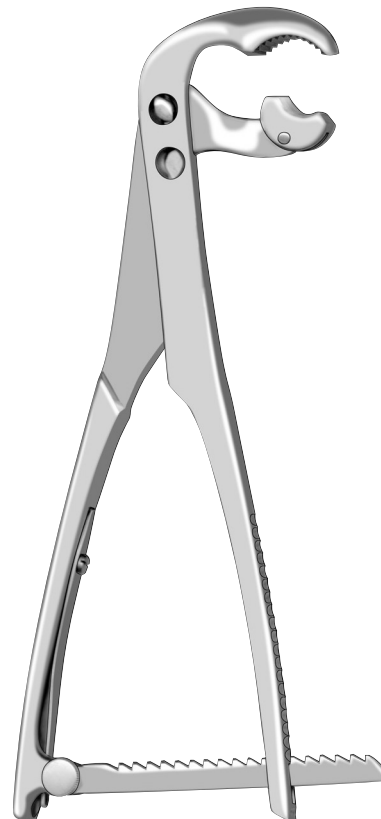

BONE HOLDING FORCEPS

Angled

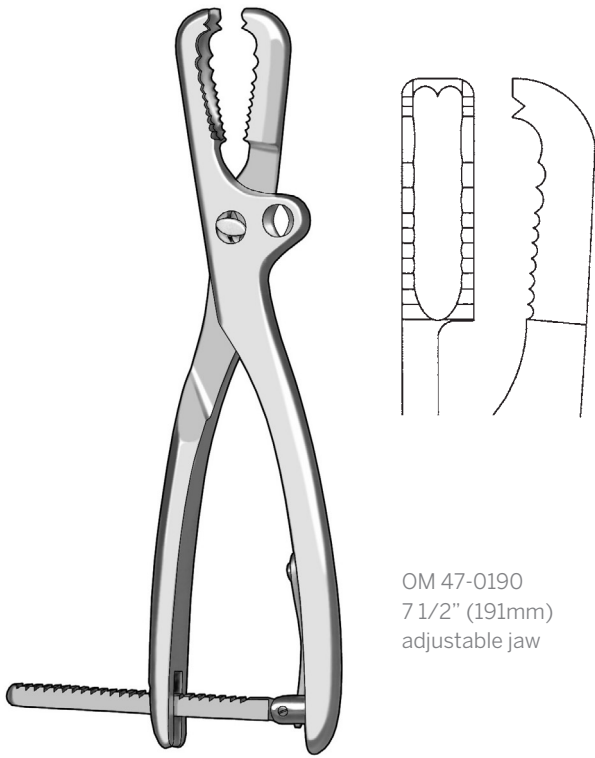

OM 47-0190
7 1/2" (191mm)
adjustable jaw

FARABEU-F-LAMBOTTE BONE HOLDING FORCEPS



OM 47-0192
10 1/2" (267mm)
adjustable jaw

FARABEU-F-LAMBOTTE BONE HOLDING FORCEPS



OM 47-0194 9" (229mm)
OM 47-0196 10" (254mm)

FARABEU BONE HOLDING FORCEPS
Adjustable jaw

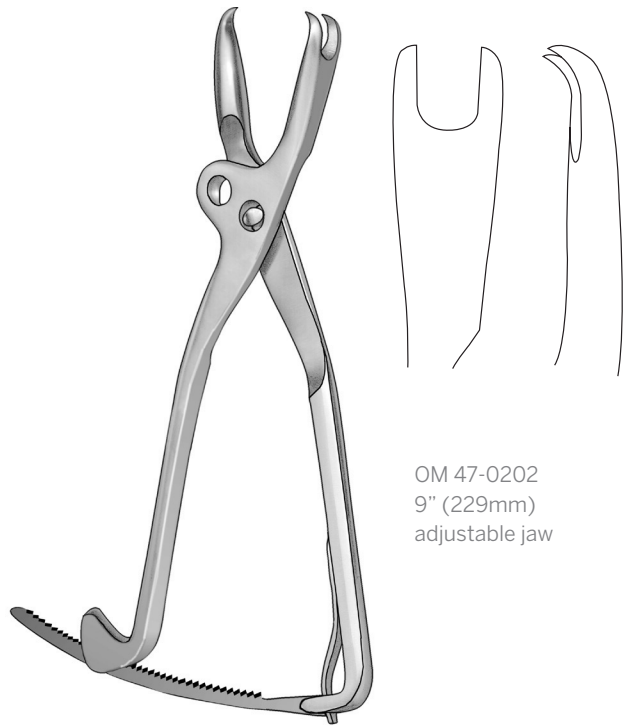

OM 47-0202
9" (229mm)
adjustable jaw

BISHOP BONE HOLDING FORCEPS

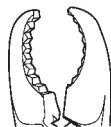

OM 47-0108
7 1/4" (184mm)
mini

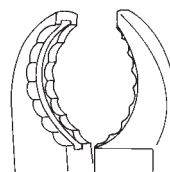

OM 47-0110
9" (229mm)

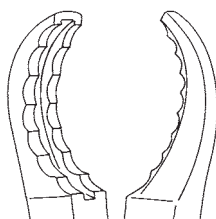

OM 47-0112
10" (254mm)

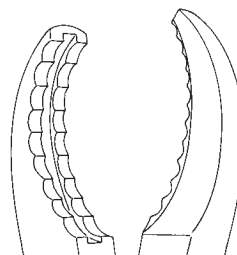

OM 47-0114
11" (280mm)

ULRICH SELF-RETAINING FORCEPS

Straight, with speed lock

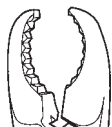

OM 47-0109
7 1/4" (184mm)

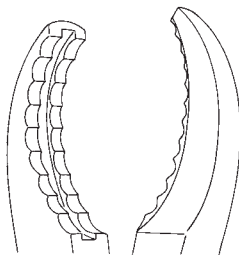

OM 47-0116
11" (280mm)

ULRICH SELF-RETAINING FORCEPS

Angular, with speed lock

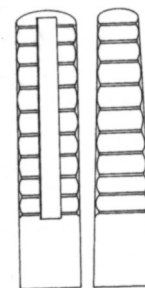

OM 47-0118
11" (280mm)
angular
with speed lock
swivel jaw

ULRICH SELF-RETAINING FORCEPS



OM 47-0089
12" (305mm)
X-large opening 30-100mm

PERIARTICULAR REDUCTION CLAMP



OM 45-0366 Medium 15" w/speedlock opening 14mm to 190mm
OM 45-0370 Large 15" w/speedlock opening 32mm to 210mm

PERIARTICULAR REDUCTION CLAMP



OM 47-0088



OM 47-0086

OM 47-0086	5 1/4"	(133mm)	small
OM 47-0087	6 1/2"	(165mm)	medium
OM 47-0088	9"	(229mm)	large

**PERIARTICULAR
REDUCTION CLAMP**

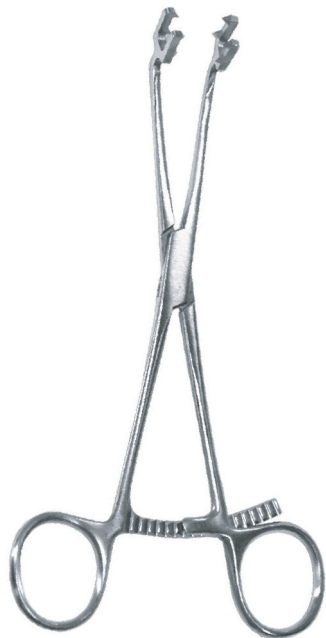

OM 47-0025	6 1/4"	(159mm)	straight
OM 47-0030	6 1/4"	(159mm)	curved

IKUTA BONE CLAMP



OM 47-0115
5 3/4" CVD (146mm)

BONE REDUCTION FORCEPS

BONE HOLDING INSTRUMENTS

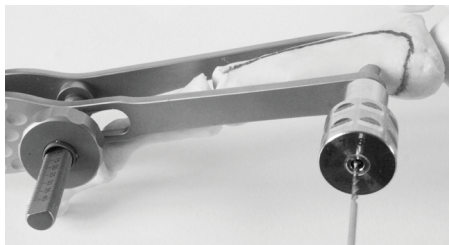
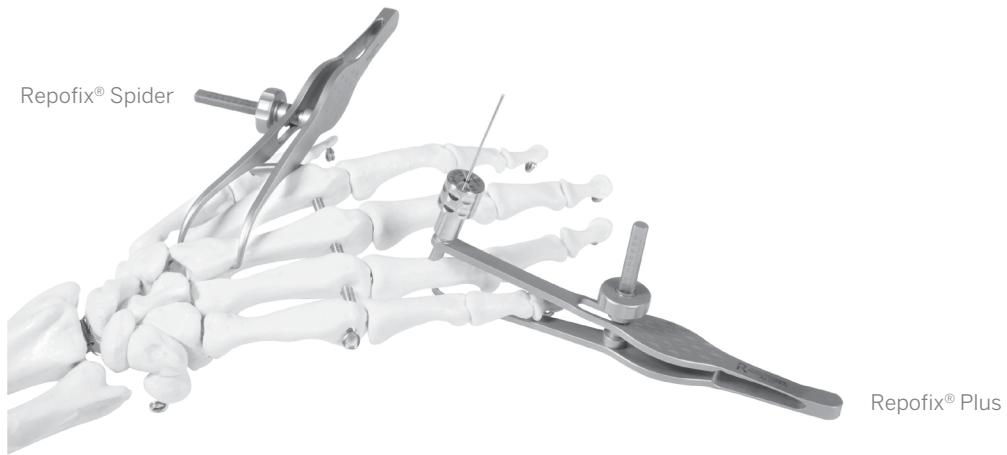

Drill



Measure



Insert screw

Forcep (only)
 OM 91-0100
 5" (127mm)
 3.5mm Inner diameter of tube, for guides and implants (screws/wires)
 40mm Maximum measurable bone width

Available Drill/Wire Guides

OM 91-0208	.8mm drill/wire opening
OM 91-0209	.9mm drill/wire opening
OM 91-0210	1.0mm drill/wire opening
OM 91-0211	1.1mm drill/wire opening
OM 91-0212	1.2mm drill/wire opening
OM 91-0213	1.3mm drill/wire opening
OM 91-0215	1.5mm drill/wire opening
OM 91-0220	2.0mm drill/wire opening



Sterilization Tray

OM 91-0010 Large enough to contain Repofix® Plus and Repofix® Spider

Repofix complete set with all guides and sterilization tray
 OM 91-0000-Set

REPOFIX® PLUS

Maintains reduction as you drill, measure, & insert screws or wires through forcep tube.

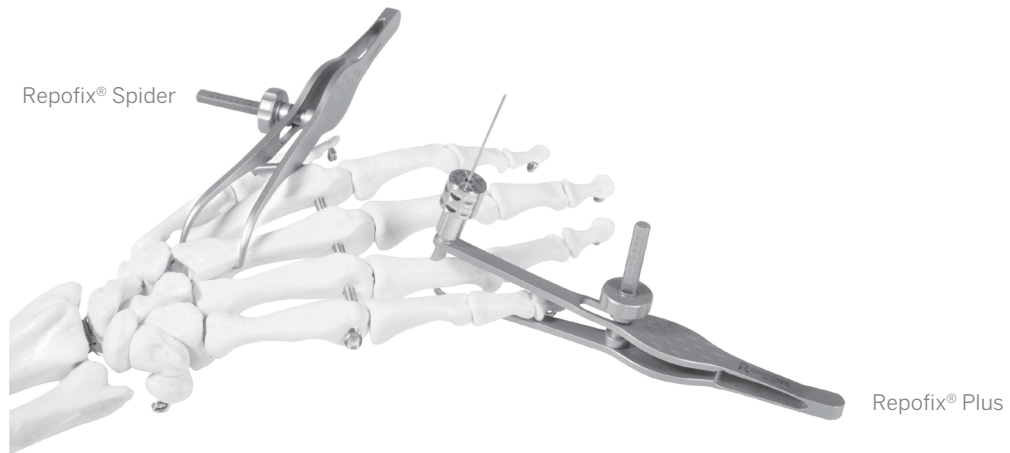

- Fine tips allow reduction in limited spaces
- Speed lock tightening wheel for controlled reduction
- Measuring scale

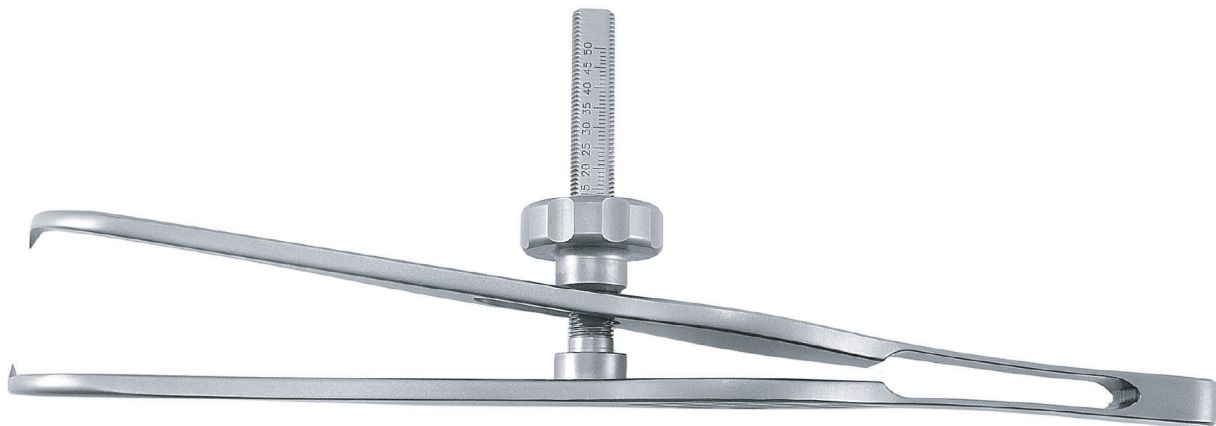

OM 91-0120
5 3/8" (137mm)
50mm Maximum measurable bone width

Sterilization Tray
OM 91-0010 Large enough to contain Repofix® Plus and Repofix® Spider

REPOFIX® SPIDER